

Examples of Acceptable / Unacceptable Lighting Fixtures

Unacceptable / Discouraged

Fixtures that produce glare and light trespass

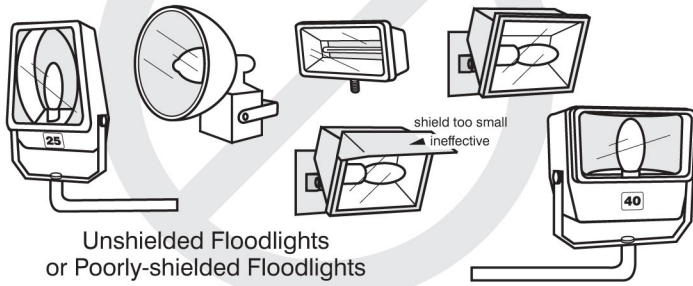

Unshielded Floodlights or Poorly-shielded Floodlights

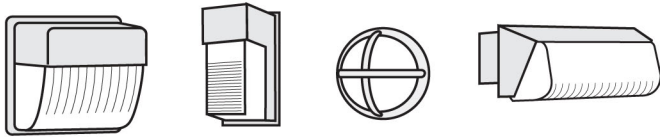

Unshielded Wallpacks & Unshielded or Poorly-shielded Wall Mount Fixtures

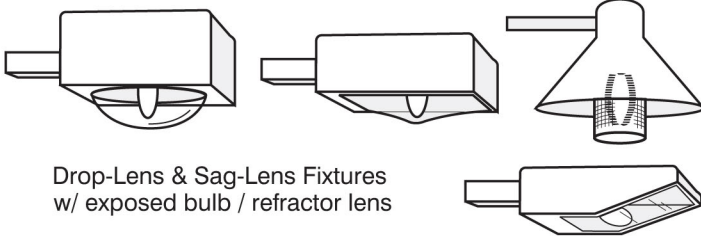
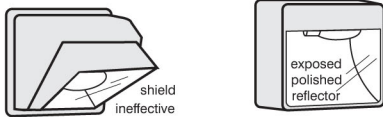

Drop-Lens & Sag-Lens Fixtures w/ exposed bulb / refractor lens

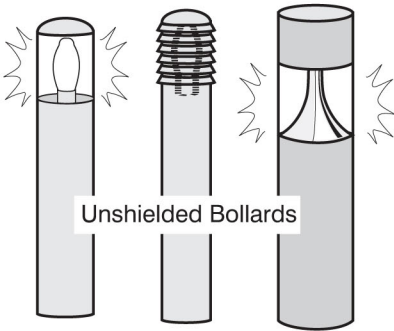

Unshielded Bollards

Unshielded Streetlight

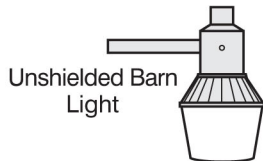

Unshielded Barn Light

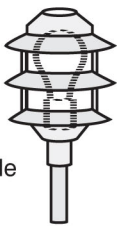

Louvered 'Marine' style Fixtures

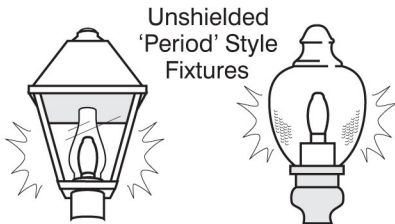

Unshielded 'Period' Style Fixtures



Unshielded PAR Floodlights

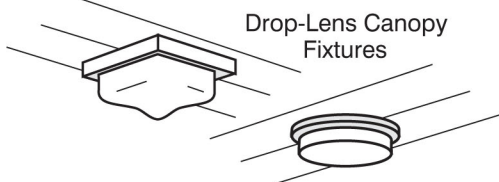

Drop-Lens Canopy Fixtures

Acceptable

Fixtures that shield the light source to minimize glare and light trespass and to facilitate better vision at night

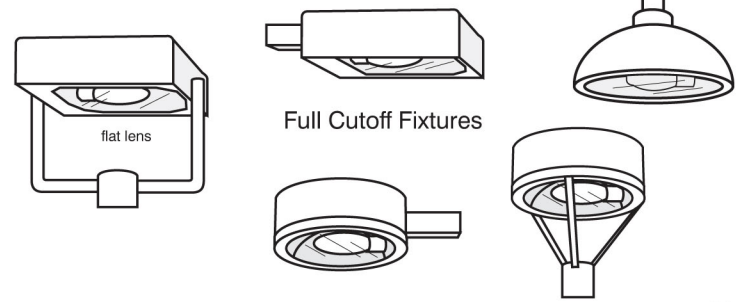

Full Cutoff Fixtures

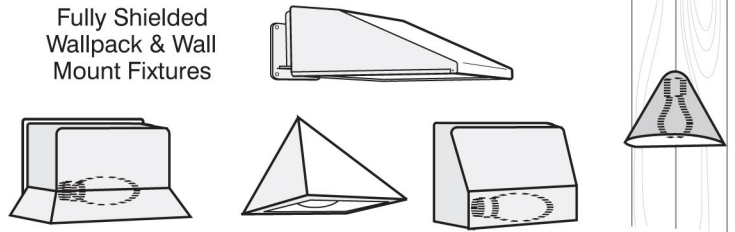

Fully Shielded Wallpack & Wall Mount Fixtures

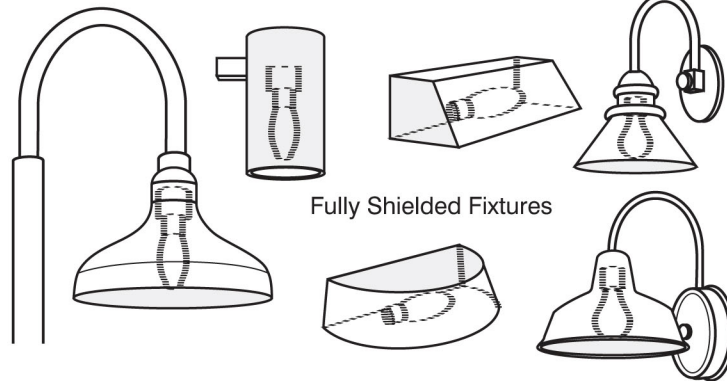

Fully Shielded Fixtures



Full Cutoff Streetlight

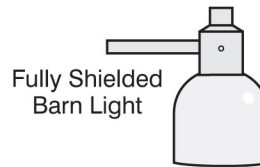

Fully Shielded Barn Light

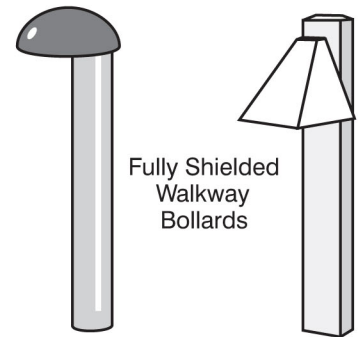

Fully Shielded Walkway Bollards



Fully Shielded Decorative Fixtures

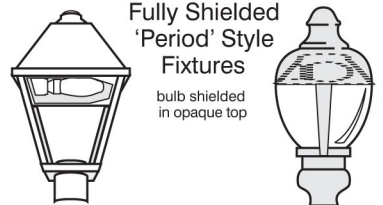

Fully Shielded 'Period' Style Fixtures

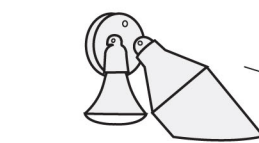

Shielded / Properly-aimed PAR Floodlights

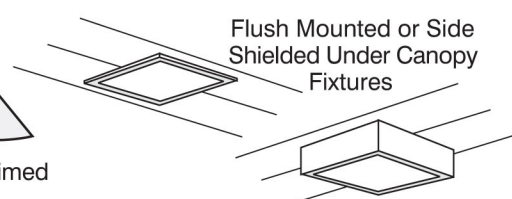

Flush Mounted or Side Shielded Under Canopy Fixtures